

MCT-HP Lead-Calcium Battery



STANDBY BATTERIES FOR LARGE POWER APPLICATIONS

Capacities 4000 Ampere-hours

C&D Technologies flooded batteries are engineered to provide superior performance and reliability over the life of the product. These batteries are designed using proprietary techniques, quality components and materials for reduced maintenance and extended battery life.

FEATURES & BENEFITS

- Optimized for today's Telecom applications
- 4000 Amp-hours capacity
- NEBS level 3 certified
- Transparent container allows visual inspection of plates
- Container wall stiffening rim to reinforce jar integrity
- Container support cradle adds durability, restrains bulge at elevated temperatures, enhances seismic performance, and functions as cell spacer
- Flame-retardant covers enhance battery plant safety
- Soft rubber post seal absorbs shock and vibration
- Long life positive plates cast with a proprietary process and alloy
- CLEI number: PWCYAV4BRA
- CPR number: 215023

SPECIFICATIONS

PLATES	Height	Width
POSITIVE NEGATIVE	18.75" (476 mm)	12.80" (325 mm)
	18.75" (476 mm)	12.80" (325 mm)
RECOMMENDED FLOAT VOLTAGE	2.20 - 2.25 vpc @ 1.215 specific gravity	
RECOMMENDED OPERATING TEMPERATURE	60°F (15°C) – 90°F (32°C)	
OPERATING TEMPERATURE LIMITS	32°F (0°C) – 120°F (49°C)	
RECOMMENDED OPERATING HUMIDITY	0% - 100% Relative Humidity (Non-Condensing)	
ELECTROLYTE HEIGHT ABOVE PLATES	3.55" (90 mm)	
SEDIMENT SPACE	1.25" (32 mm)	
ELECTROLYTE AT 77°F (25°C)	Sulfuric acid, 1.215 specific gravity nominal (optional 1.250)	
CONTAINER MATERIAL (TRANSPARENT)	High-impact, flame-retardant thermoplastic (PVC). Flammability ratings: UL94 V-0; LOI > 33	
CONTAINER SUPPORT CRADLE	High-impact, flame-retardant thermoplastic. Flammability ratings: UL94 V-0; LOI > 28; ASTM D-635 self-extinguishing	
COVER	High-impact, flame-retardant thermoplastic (PVC), with tongue-and-groove seal. Flammability ratings: UL94 V-0; LOI > 33; ASTM D-635 self-extinguishing	
SEPARATOR	PVC	
RETAINER	Fibrous glass mat	
SAFETY VENT SYSTEM	Flame arrester type	
TERMINALS	Four 1.375 in (35mm) square posts per cell	
ELECTROLYTE WITHDRAWAL TUBES	Two per cell	
INTERCELL CONNECTORS	Lead-plated copper (Stainless steel hardware)	

FLOODED



APPLICATIONS

- Telephone Central Offices
- Mobile Telephone Switching Office
- Cable Head End Sites
- Fiber Optic Regenerator Sites
- Microwave Repeater Sites
- Telephone & Internet Network Nodes

SPECIFICATIONS

MODEL NAME	CELL PER UNIT	PLATES PER CELL	INTERNAL RESISTANCE** (OHMS)	DIMENSIONS INCHES (mm)			WEIGHT LBS. (kg)		ELECTROLYTE PER CELL GAL (L)*
				LENGTH	WIDTH	HEIGHT	NET FILLED	DOM. PACKED	
MCT-4000 HP	1	45	.000094	15.19 (386)	17.32 (440)	28.9 (735)	675 (306)	720 (327)	17 (64)

NOTE: *Electrolyte weighs approximately 10 lbs. per gallon (1.210 kg per liter). **Includes connector.

RATINGS TABLE: AMPERES 1.215 SPECIFIC GRAVITY

MODEL NAME	FV/CELL	30 MIN	1 HR	2 HR	3 HR	4 HR	5 HR	8 HR
NOMINAL RATES AT 77°F (25°C) (INCLUDES CONNECTOR VOLTAGE DROP) • AMPERES								
MCT-4000 HP	1.88	1144.3	1062.7	896.6	747.9	632.8	548.2	397.4
	1.86	1315.1	1199.2	978.7	802.9	676.8	586.1	424.2
	1.84	1479.7	1307.4	1024.7	833.2	703.6	611.2	444.1
	1.80	1801.0	1531.2	1141.2	910.2	762.4	659.3	475.2
	1.75	2146.1	1713.3	1214.7	959.9	802.6	693.8	500.0

Additional ratings and application information are available in the Battery Selection Program found at www.cdstandbypower.net

RACK SPECIFICATIONS: FOR MCT-HP BATTERIES WITH PLATES PARALLEL TO RACK RAILS

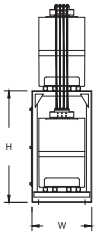
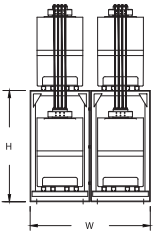
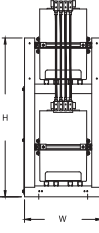
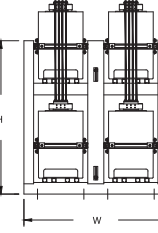
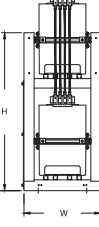
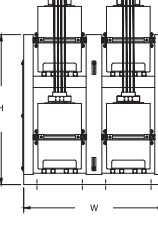
STANDARD (NON-SEISMIC) (UBC 0)											
TWO TIER/ONE ROW MODEL RD02083-(L) WIDTH: 22.50 IN (572 MM) HEIGHT: 42.00 IN (1067 MM)						TWO TIER/TWO ROW MODEL RD02059-(L) WIDTH: 45.38 IN (1153 MM) HEIGHT: 42.00 IN (1067 MM)					
Part Number	Number of Cells	Length IN (mm)	Weight LBS (kgs)			Part Number	Number of Cells	Length IN (mm)	Weight LBS (kgs)		
RD02083-08	12	96 (2438)	310 (141)			RD02059-08	24	96 (2438)	600 (272)		
RD02083-16	24	192 (4877)	625 (284)			RD02059-16	48	192 (4877)	1200 (544)		
SEISMIC BELLCORE ZONE 2 (UBC 3&4)											
TWO TIER/ONE ROW MODEL RD02083-(L)BC2 WIDTH: 28.50 IN (724 MM) HEIGHT: 58.50 IN (1486 MM)						TWO TIER/TWO ROW MODEL RD02059-(L)BC2 WIDTH: 55.75 IN (1416 MM) HEIGHT: 58.50 IN (1486 MM)					
Part Number	Number of Cells	Length IN (mm)	Weight LBS (kgs)			Part Number	Number of Cells	Length IN (mm)	Weight LBS (kgs)		
RD02083-08BC2	12	96 (2438)	575 (260)			RD02059-08BC2	24	96 (2438)	1020 (464)		
RD02083-16BC2	24	192 (4877)	1150 (521)			RD02059-16BC2	48	192 (4877)	2000 (906)		
SEISMIC BELLCORE ZONE 4 (UBC 4+)											
TWO TIER/ONE ROW MODEL RD02083-(L)BC4 WIDTH: 28.50 IN (724 MM) HEIGHT: 58.50 IN (1486 MM)						TWO TIER/TWO ROW MODEL RD02059-(L)BC4 WIDTH: 55.75 IN (1416 MM) HEIGHT: 58.50 IN (1486 MM)					
Part Number	Number of Cells	Length IN (mm)	Weight LBS (kgs)			Part Number	Number of Cells	Length IN (mm)	Weight LBS (kgs)		
RD02083-08BC4	12	96 (2438)	575 (260)			RD02059-08BC4	24	96 (2438)	1100 (499)		
RD02083-16BC4	24	192 (4877)	1175 (533)			RD02059-16BC4	48	192 (4877)	2200 (997)		

NOTES: 1. In the Part Number the (L) indicates the Length of the Part Number in feet. 2. For rack lengths not shown contact C&D Engineering. 3. Rack width does not include thickness of crossbracing. Increase width by 0.5 inches (12.7 mm) when this dimension is critical. 4. Standard cell installation on racks is with plates parallel to rack rails. 5. For other cell configurations and rack types, contact C&D Engineering.

“NEBS CERTIFIED” MCT-HP RACKS

		RACK DIMENSIONS			MAXIMUM RACK DIMENSIONS INCLUDING END RAILS, BRACES & BOLTS HEIGHT TO THE TOP OF THE BATTERY POST
		Length	Width	Height	
2T1R FOR 24 CELLS:					
*Plates Parallel	RD04258-16N4	192.00" 4877 mm	25.88" 657 mm	58.13" 1476 mm	192"L x 27.5"D x 73.06"H 4877 mm x 699 mm x 1856 mm
Plates Perpendicular	RD04259-18N4	216.00" 5486 mm	24.13" 613 mm	58.13" 1476 mm	218.1"L x 25.7"D x 73.06"H 5540 mm x 653 mm x 1856 mm
2T2R FOR 24 CELLS:					
*Plates Parallel	RD04262-08N4	96.14" 2442 mm	51.50" 1308 mm	57.88" 1470 mm	98.21"L x 54.1"D x 72.81"H 2495 mm x 1374 mm x 1849 mm
Plates Perpendicular	RD04263-09N4	108.50" 2756 mm	48.00" 1219 mm	57.88" 1470 mm	111.20"L x 50.6"D x 72.81"H 2824 mm x 1285 mm x 1849 mm
2T2R FOR 48 CELLS:					
*Plates Parallel	RD04262-16N4	191.39" 4861 mm	51.50" 1308 mm	57.88" 1470 mm	192"L x 54.1"D x 72.81"H 4877 mm x 1374 mm x 1849 mm
Plates Perpendicular	RD04263-18N4	216.5" 5499 mm	48.00" 1219 mm	57.88" 1470 mm	218.2"L x 50.6"D x 72.81"H 5537 mm x 1285 mm x 1849 mm

*Standard cell installation is with plates parallel to rack rails.

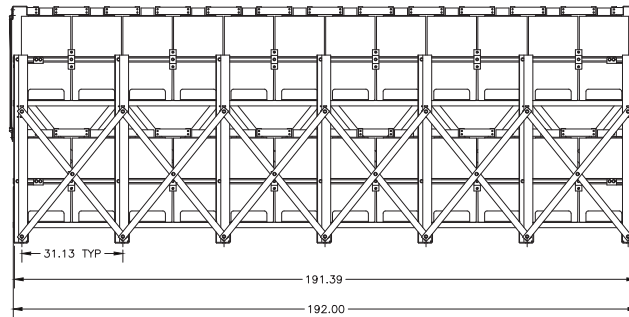
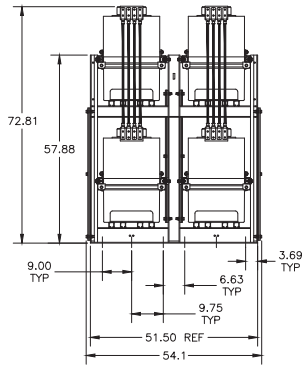

Shown: RD04262-16N4, 2T2R 16ft long MCT-4000HP rack with 48 cells.
For NEBS zone 2 racks, use suffix “-N2” in place of “-N4”. Dimensionally, they are the same.

HIGH QUALITY BATTERY RACKS AND SPILL CONTAINMENT SYSTEMS ARE C&D TECHNOLOGIES SPECIALTIES

C&D Technologies offers quality racks to support its highly regarded MCT-HP product line. The racks offer a range of quality features while maintaining a competitive price structure.

- Epoxy Coated — 4 Rail Design
- Rugged “C-Channel” Frame Design
- Welded Steel Frames with an Acid Resistant, Electro-statically Applied Epoxy Powder Coat, ANSI 61 Gray
- Rails Accommodate Clip Nuts for Bolt-on Accessories
- Simplified Installation with Accessible Anchor Bolt Locations
- Racks are Shipped Unassembled
- Available for all Seismic Zones

C&D Technologies offers spill containment systems designed to meet and, in many cases, exceed all applicable Federal and State regulations by providing you with reliable, solid performance for hazardous material spills.

- Assembled with Flanges out or with Flanges in to Maximize Aisle Space
- PVC Coated Metal Construction
- Modular Design for Easy Installation and Maintenance
- Reusable in the Event of Future Expansion
- Complete System with Neutralizing and Absorbing Pillows



©2020 C&D Technologies Inc. Any data, descriptions or specifications presented herein are subject to revision by C&D Technologies, Inc. without notice. While such information is believed to be accurate as indicated herein, C&D Technologies, Inc. makes no warranty and hereby disclaims all warranties, express or implied, with regard to the accuracy or completeness of such information. Further, because the product(s) featured herein may be used under conditions beyond its control, C&D Technologies, Inc. hereby disclaims all warranties, either express or implied, concerning the fitness or suitability of such product(s) for any particular use or in any specific application or arising from any course of dealing or usage of trade. The user is solely responsible for determining the suitability of the product(s) featured herein for user’s intended purpose and in user’s specific application.

200 Precision Drive, Suite 150 Horsham, Pennsylvania 19044 USA | www.cdtechno.com

