



Liebert® EXL S1

from 250 to 1200 kW

Beyond the Power Revolution



Liebert® EXL S1 From 250 to 1200 kW

About Vertiv™

Vertiv brings together hardware, software, analytics and ongoing services to ensure its customers' vital applications run continuously, perform optimally and grow with their business needs. Vertiv solves the most important challenges facing today's data centers, communication networks and commercial and industrial facilities with a portfolio of power, cooling and IT infrastructure solutions and services that extends from the cloud to the edge of the network. Headquartered in Columbus, Ohio, USA, Vertiv employs around 20,000 people and does business in more than 130 countries. For more information, and for the latest news and content from Vertiv, visit [Vertiv.com](https://www.vertiv.com).

OUR PURPOSE

We believe there is a better way to meet the world's accelerating demand for data - one driven by passion and innovation.

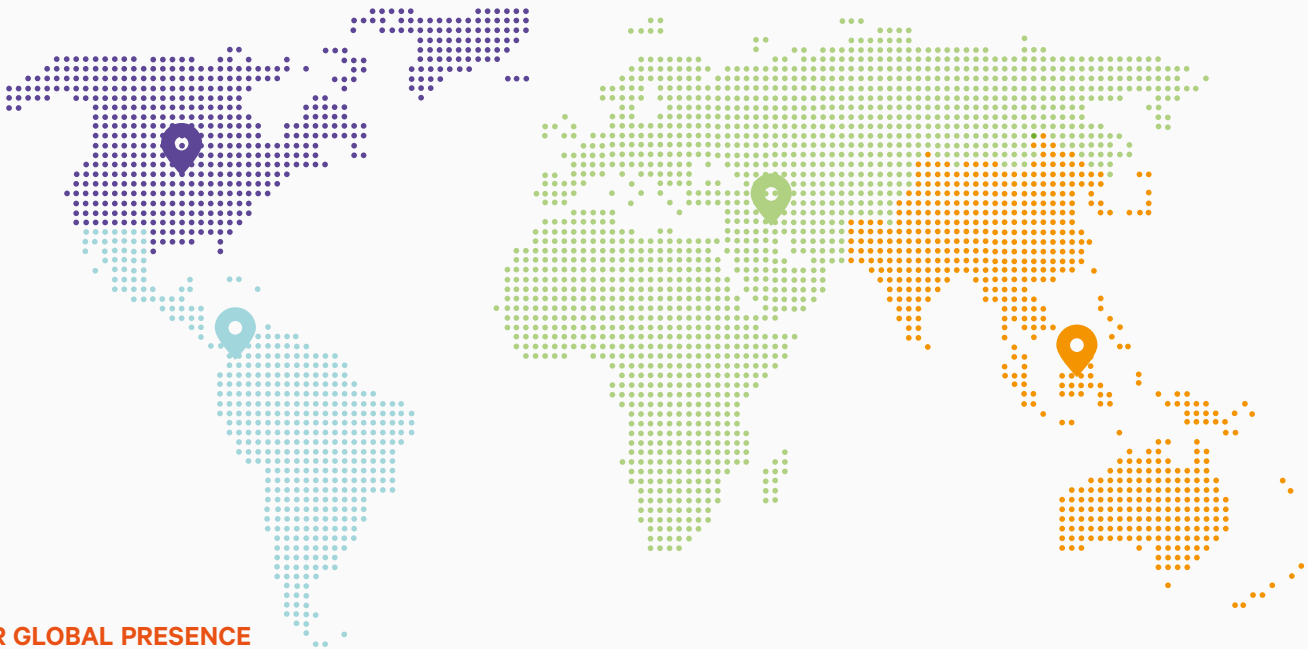

OUR GLOBAL PRESENCE

Manuf. and Assembly Locations **28**
Service Centers **250+**
Service Field Engineers **2,650+**
Technical Support/Response **300+**
Customer Experience Centers/Labs **16**



US AND CANADA

Manuf. and Assembly Locations **13**
Service Centers **100+**
Service Field Engineers **850+**
Technical Support/Response **120+**
Customer Experience Centers/Labs **4**



LATIN AMERICA

Manuf. and Assembly Locations **1**
Service Centers **20+**
Service Field Engineers **240+**
Technical Support/Response **20+**
Customer Experience Centers/Labs **2**



EUROPE, MIDDLE EAST AND AFRICA

Manuf. and Assembly Locations **9**
Service Centers **70+**
Service Field Engineers **590+**
Technical Support/Response **90+**
Customer Experience Centers/Labs **5**



ASIA PACIFIC

Manuf. and Assembly Locations **5**
Service Centers **60+**
Service Field Engineers **970+**
Technical Support/Response **80+**
Customer Experience Centers/Labs **5**

OVERVIEW

The Liebert® EXL S1 is a monolithic, transformer-free UPS that features optimized, industry leading footprint and power density, excellent operating efficiency and robust electrical protection to achieve superior cost savings.

Key Benefits

- Space-saving design minimizes footprint
- Maximizes active power capacity
- Reduces operating expenses
- Easy to service and install
- Flexible configurations
- Eliminates upstream electrical disturbances
- Ensures robust power protection
- Compatible with modern electrical loads
- Intelligent and secure control is customizable by user
- Flexible energy store options

With Vertiv™ Services, your critical systems are fully maintained. Proactive support extends the life of your power systems, decrease your capital investment, optimizes system efficiency and effectiveness, and increases overall system availability.

Vertiv's service program is designed to ensure that your critical power protection system is maintained in an optimum state of readiness at all times. Vertiv™ LIFE™ Services leverages the embedded intelligence in your equipment, IoT technology, and the expertise and resources of our service organization to deliver a connected service experience that optimizes equipment performance and reliability, reduces downtime and minimizes overhead costs.



Liebert EXL S1 250-400kVA/kW



Liebert EXL S1 500-600kVA/kW



Liebert EXL S1 625-800kVA/kW



Liebert EXL S1 1000-1200kVA/kW

Standard Features

- Redundant DC variable speed fans
- Advanced compact power core
- Transformer-free design
- Up to 99% efficient
- Unity/Symmetrical power factor
- 100kA short circuit withstand rating
- Advanced status-at-a-glance touchscreen control panel
- Lithium-ion battery compatible
- Parallel up to 8 units
- Top and bottom entry cable access
- Front and top only service access
- Intelligent paralleling mode
- Parallel UPS system control and monitoring from a single touchscreen control panel
- Vertiv LIFE Services Remote Diagnostic and Preventive Monitoring

Optional Features

- Dynamic Online (VI) mode
- Single or dual input
- DC battery ground fault detection
- Distributed paralleling
- Seismic anchoring kit
- Load bus synchronization
- Backfeed disconnect
- Bypass current sharing inductors
- Emergency Power Off
- Unity communications card allowing dual simultaneous protocols
- FCC Part 15 compliance

Liebert® EXL S1 From 250 to 1200 kW

Capacity & Installation Flexibility from 250 kW up to 9.6 MW

Liebert® EXL S1 features a transformer-free design with full IGBT three-level double conversion technology, providing extraordinary savings on installation and running costs, while at the same time delivering first class load protection.

Liebert EXL S1 also features a full IGBT three-level rectifier allowing for electrical infrastructure cost saving, reducing the size of gensets, circuit protection, cabling and transformers.

Flexibility and Compatibility

Liebert EXL S1 can be fully adapted to meet diverse system requirements in terms of power capacity and redundancy allowing for different system designs, thus ensuring maximum flexibility:

- Output Power Factor up to 1
- No power derating from 0.4 lagging to 0.7 leading
- Optimum space/power ratio

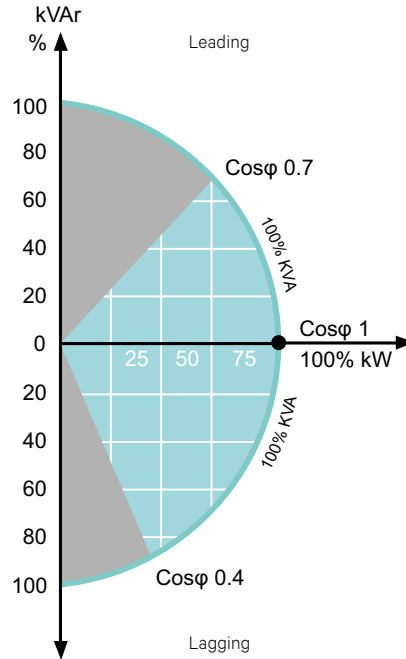

Figure 8: Power Factor Output Diagram

Maximized active power, high efficiency and complete compatibility for modern, mission critical IT loads.

Features and Performance

- Transformer-free design
- Full IGBT three-level NPC2 topology
- Excellent input performances:
 - - PF > 0.99
 - - THDi < 3%
- Automatic output power upgrade of up to +10%
- Three wire electrical compatibility
- Distributed parallel capabilities
- Seismic compliance



Improved Efficiency

Liebert® EXL S1 delivers an outstanding double conversion efficiency of up to 97%, which further increases up to 99% with the dynamic online mode, consequently reducing operating costs and energy dissipation (kW) to a minimum. This significantly minimizes the consumption of the cooling system, providing an overall TCO reduction and rapid payback time.

Furthermore, through its intelligent ECO mode efficiency and the intelligent paralleling feature Liebert EXL S1 can optimize efficiency even at partial load achieving additional superior cost savings.

Liebert EXL S1 levels of efficiency and consequent electricity cost savings can be attributed to:

- Latest generation IGBT
- Adoption of a three-level NPC2 topology for both rectifier and inverter
- DC controlled fan speed
- Intelligent paralleling mode
- Advanced digital technology and fast transfer

The seamless activation of Liebert EXL S1's functioning modes ensures the highest level of efficiency without compromising power quality and availability.

The dynamic online mode ensures Class 1 output performance under most stringent conditions:

- Network fault (voltage variation, high/low impedance mains failures)
- Load fault (short circuit downstream of the UPS)
- Type of load connected (PDU transformer)

The unit is able to discriminate between various types of interferences and rapidly respond, while at the same time ensuring compatibility with downstream equipment such as servers, transformers, STS or mechanical loads.

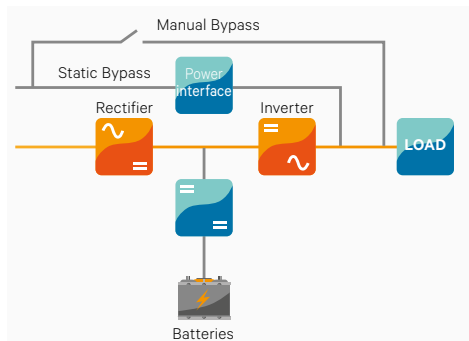

Maximum Power Control (VFI)

Provides the highest level of power conditioning and protects the load from all electrical network disturbances.

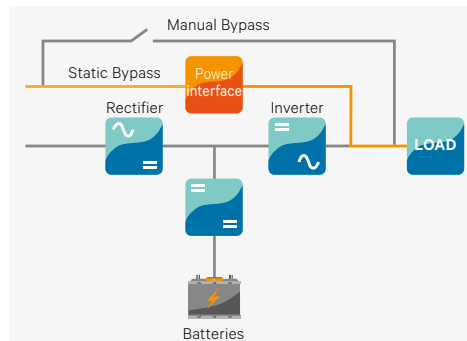

Maximum Energy Saving (VFD)

Detects when conditioning is not required and allows the energy flow to passthrough he bypass line.

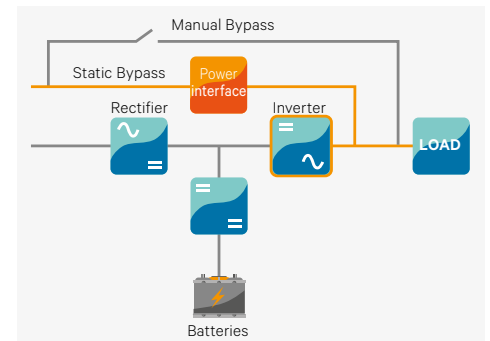

Dynamic Online, High Efficiency & Power Conditioning (VI)

Compensates the load THDi, PF and main sags and swells, ensuring fast transfer output performance.

Dynamic Online mode: No more availability tradeoff with efficiency

Dynamic Online mode is the latest high efficiency mode of operation offered by Vertiv, developed for those that do not want to trade off any level of availability for incremental gains in efficiency.

Dynamic Online mode enables **operating efficiency up to 99% without sacrificing availability**. In fact, while in this mode, the inverter can instantaneously assume the load and maintain the output voltage within the IEC 62040 Class 1 specification, thus offering the same level of availability typically achieved in a double conversion operating mode.

Dynamic Online mode is therefore able to combine the superior availability of a double conversion operating mode with the excellent energy cost savings of a high efficiency mode for a reduced total cost of ownership.

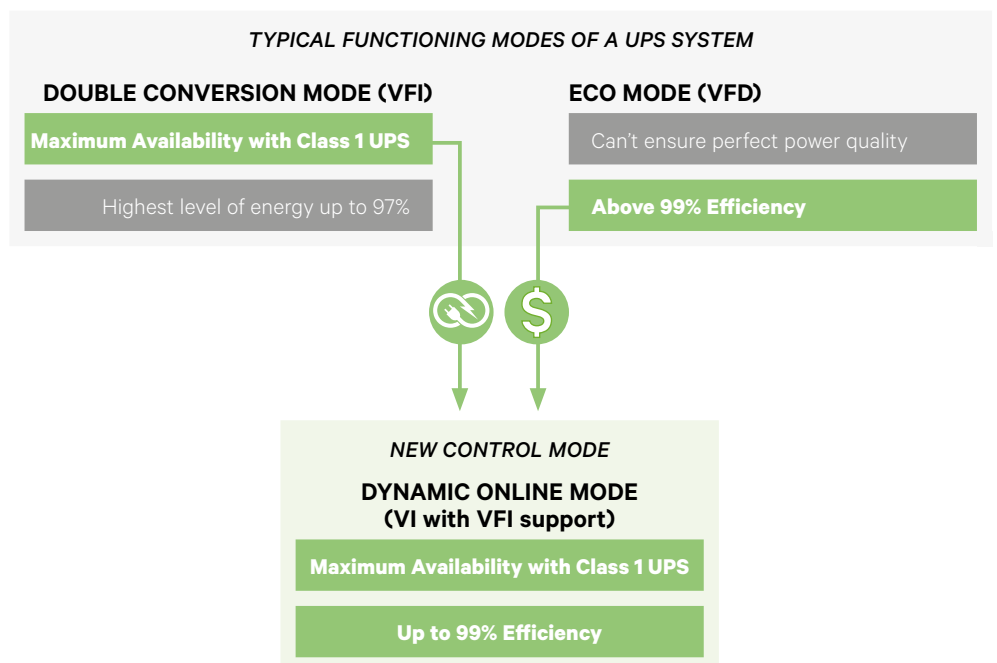

Liebert® EXL S1 From 250 to 1200 kW

Liebert® EXL S1 Dynamic Grid Support Feature

Intermittent renewables continue to challenge conventional energy generation. Evening out this renewable supply requires new energy storage services both in front of the meter and behind. Operators of data centers and other types of critical infrastructure have a key role to play in this shifting energy landscape which presents new ways to generate revenue and lower costs.





Liebert EXL S1 can provide frequency regulation by controlling the input power to support services such as frequency regulation-up, regulation-down, or both via charging and discharging of the battery.

Dedicated controls always maintain the necessary battery energy to support the critical load in event of an outage.



When operating in Dynamic Grid Support the UPS provides a fast response to react to the grid services commands. The total response time from the moment receiving the signal for the Dynamic Grid Support to the time reaching the specified power is below 0.5 second.

Offering your site's energy demand flexibility will enable access to new revenue streams and cost saving opportunities. With a focus on your site's primary function these benefits can be realized with Liebert EXL S1 without operational impacts.

Dynamic Grid Support is available for a number of markets, including:

-  **Data Center**
-  **Commercial**
-  **Industrial**
-  **Telecommunications**
-  **Transportation**

APPLICATION EXAMPLE

-  **A 20 MW data Center**
-  **can generate revenue up to**
-  **1.4 million each year**

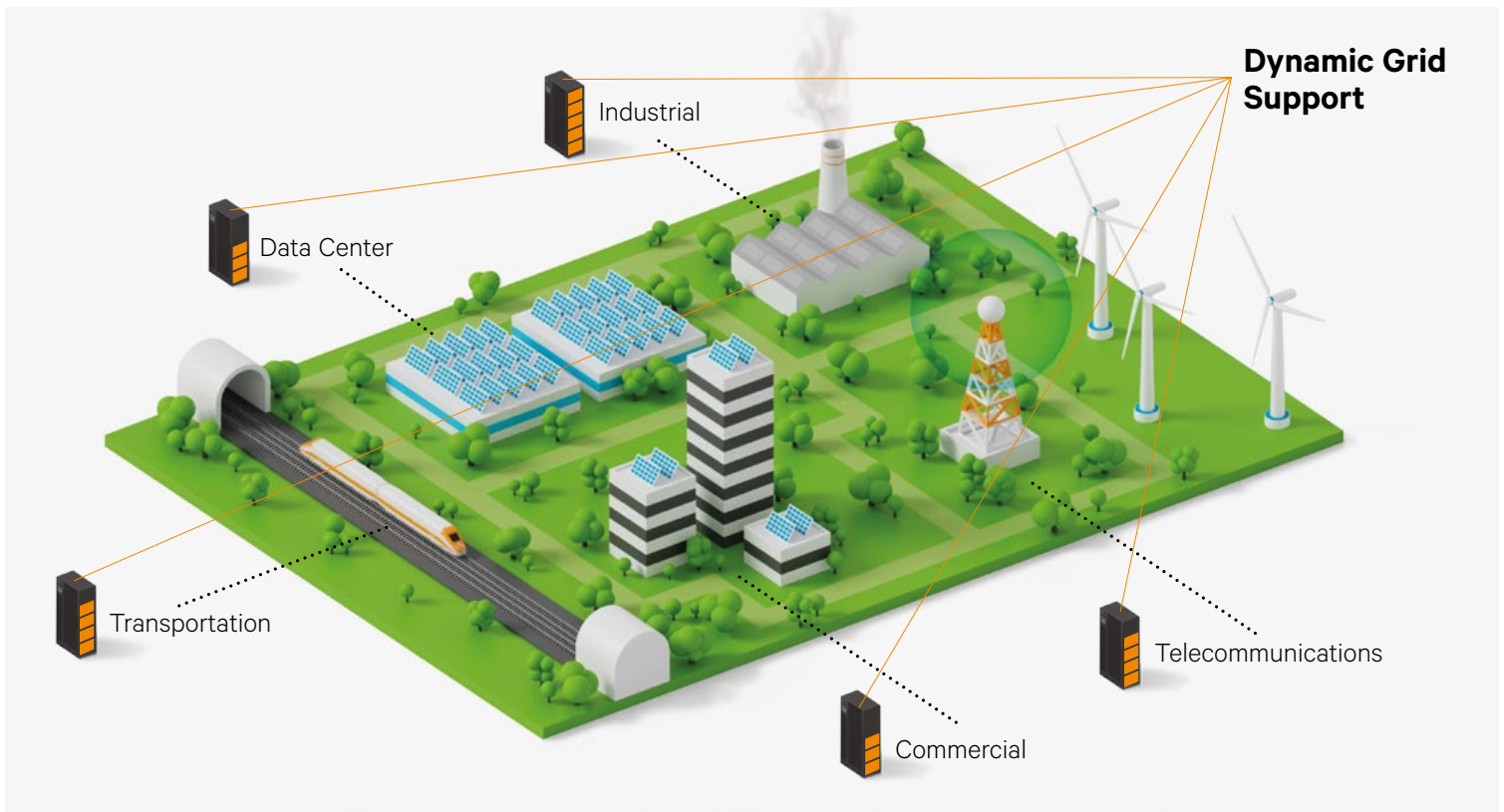

Intelligent Paralleling

Liebert® EXL S1 Intelligent Paralleling Feature

Activating the intelligent paralleling feature optimizes efficiency at partial load, thus achieving superior running cost savings. Enabling this feature allows the system to automatically adapt capacity to meet immediate load requirements by switching excess units to standby mode, while ensuring continued system availability. Furthermore, the Intelligent Paralleling feature allows each Liebert EXL S1 unit to operate in standby mode for the same amount of time, ensuring an equal life-span of module components.

This intelligent paralleling feature further maximizes Liebert EXL S1's double conversion efficiency at partial load and allows for an overall energy dissipation and TCO reduction.

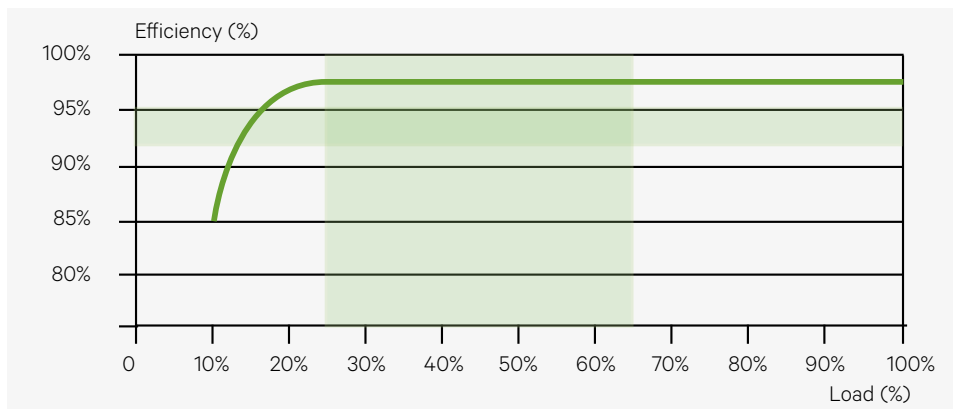

Liebert EXL S1 AC/AC efficiency with Intelligent Paralleling feature



Parallel Configurations

The Liebert EXL S1 can be connected with up to 8 units in parallel, where single units can be serviced while the remaining units continue to power the load. A Liebert EXL S1 unit continues to

operate even while it's being upgraded to a parallel system due to the upgrade occurring via software settings. Liebert EXL S1 can support distributed parallel configurations providing maximum energy

saving via double conversion, dynamic online, and intelligent ECO mode, allowing to operate with a system efficiency of up to 99%.

Distributed Parallel Configuration

Paralleling single Liebert EXL S1 units offers advanced scalability. In a distributed parallel configuration, each unit has a dedicated static bypass switch, providing parallel operation without the need for a system control cabinet, thus reducing initial installation costs.

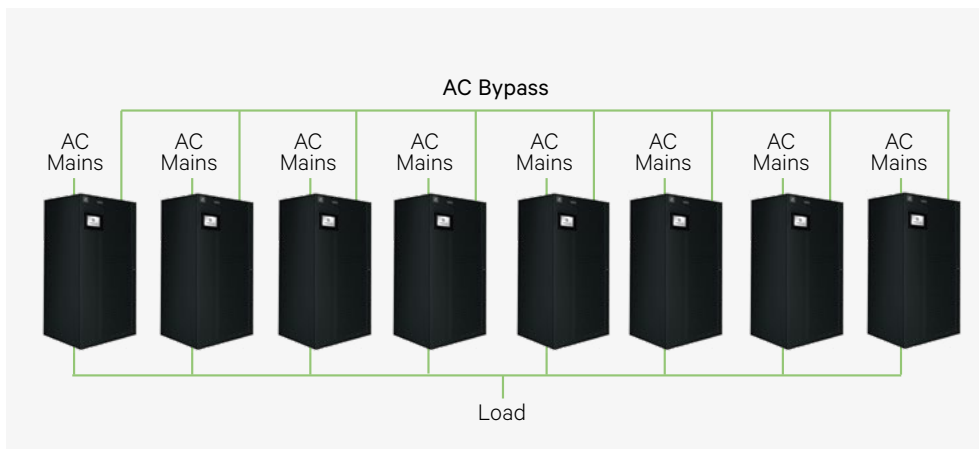

Liebert EXL S1 distributed parallel configuration, with 8 UPS units in parallel

Liebert® EXL S1 From 250 to 1200 kW

User Interface and Advanced Diagnostic

Liebert® EXL S1 makes your mission critical space a peaceful place through its advanced diagnostic capability, measuring and logging, enhanced event analysis as well as an intelligent colored multi-language touch screen display.

Liebert EXL S1 advanced DSP control platform together with the patented Vector Control technology enables increased performance of three-level power converters and real time control of output power quality, guaranteeing continuous operation and premium protection for your customer's business.

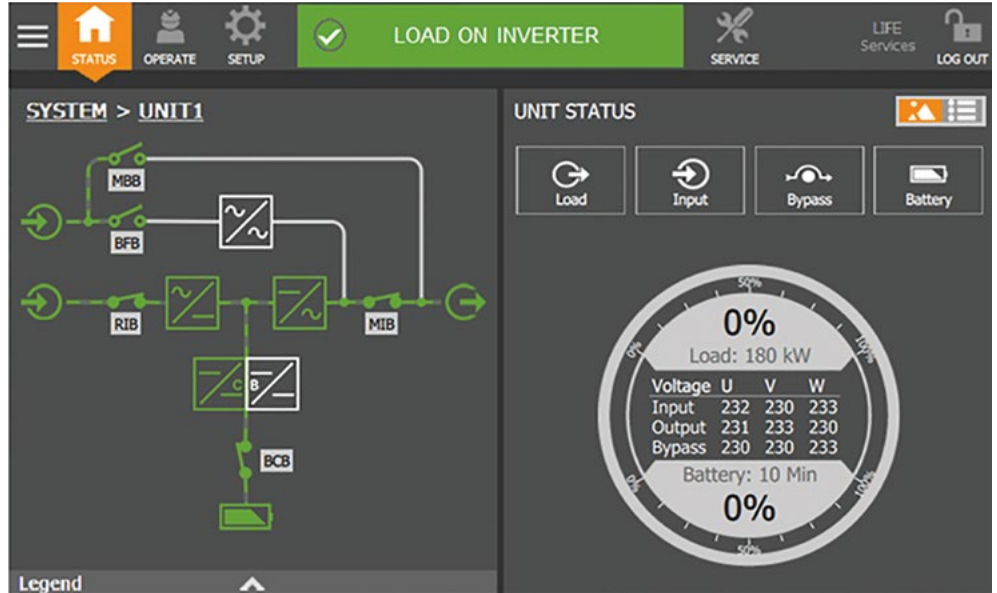

Bypass Input

Voltage and frequency measurements.

Mains Input

Current, voltage and frequency values of the three input phases.

Warning/fault

Alerts of anomalies on bypass, rectifier, inverter, booster/charger, battery and load.

Events log

Date and time of important UPS events, alarms and other warnings.

Measurements

Voltage, current and frequency values of each internal functional block.

Battery

Status/values including temperature, cell voltage, capacity run time and testing.

Vertiv™ LIFE™ Services

Status of Vertiv LIFE Services connections and calls.

Tools

LCD settings and language selection.

Output

Voltage, current, frequency, and battery measurements.

Reduced TCO

Neutral Carbon Footprint

Liebert® EXL S1's new generation architecture has been designed to reduce energy and heat dissipation, consequently minimizing the demand and consumption of air conditioning systems.

The combination of these factors, coupled with a double conversion efficiency of up to 97%, reduces CO₂ emissions to a minimum. This contributes to ensuring that your customers' data centers are a step closer to meeting the industry's environmental and efficiency compliance standards.



97%

Double Conversion

Efficiency



CO₂

950 tons

of CO₂ saved every year

Advanced control diagnostic, excellent operating efficiency, intelligent paralleling feature, minimum footprint and high energy density make Liebert EXL S1 the perfect UPS to deliver secure power to all mission critical applications, maximum energy saving and rapid return on investment.

Liebert EXL S1 provides system capacity from 250 kW up to 9.6 MW which can be adapted according to diverse design requirements in terms of flexibility, redundancy and system reliability.

Furthermore, its high power density in a minimum space allows customers to maximize the number of racks and servers housed in their data center, thus granting more space for IT equipment.

The Liebert EXL S1 technology, has brought extraordinary benefits in terms of:

- Zero impact on upstream infrastructure
- Perfect compatibility with modern mission critical loads
- Enhanced performances for maximum energy saving
- CO₂ emission reduction
- Maximum system flexibility for all installations
- Reduced TCO



Liebert® EXL S1 From 250 to 1200 kW

Vertiv™ LIFE™ Services Remote Diagnostic and Preventive Monitoring

Vertiv's service program is designed to ensure that your critical power protection system is maintained in an optimum state of readiness at all times.

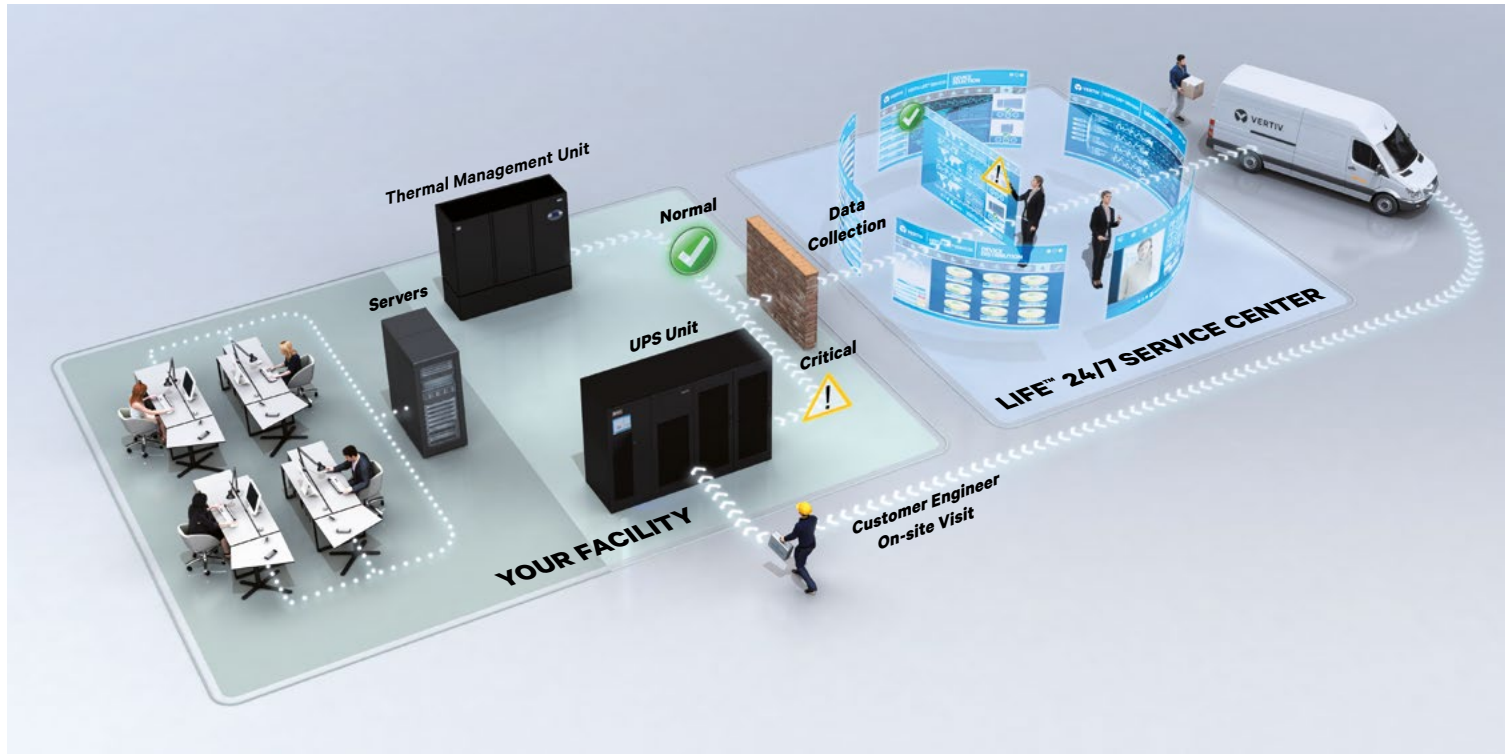

The **Vertiv™ LIFE™ Services** Remote Diagnostic and Preventive Monitoring provides early warning of UPS conditions and out of tolerances. This allows effective proactive maintenance, fast incident response and remote trouble shooting, giving customers complete security and peace of mind. With Vertiv LIFE Services you will benefit from:

Uptime Assurance

Constant monitoring of UPS parameters, thus maximizing the system's availability.

First Time Fix Rate

Pro-active monitoring and data measuring ensure that when our customer engineers are dispatched on-site, they arrive prepared for first time resolution.

Proactive Analysis

From Vertiv LIFE Services centers, our experts proactively analyze the data and trends of your equipment, to recommend actions to ensure their best performance.

Minimized Total Cost of Ownership of Your Equipment

The continuous monitoring of all relevant parameters in turn maximizes unit performance, reduces on-site maintenance and extends the life of your equipment.

Fast Incident Response

Vertiv LIFE Services allows for immediate definition of the best course of action, as a result of the regular communication between your Liebert® EXL S1 system and our Vertiv LIFE Services centers.

Reporting

You will receive a comprehensive report detailing the working order of your equipment and its operational performance.

Customer Monitoring Interfaces

LCD Touch Screen Features

- High security access with separate password levels for users and service engineers
- User-friendly graphical interface
- Single-line mimic diagram showing system status
- Dedicated warning/fault and event log page used to monitor USP status and important events
- Dedicated measurements page for all UPS internal functional blocks

Hardware Connectivity

Liebert® EXL S1 allows for the monitoring and control of networked UPS, through different protocol options:

- The integration of UPS with Building Monitoring and Automation Systems via MODBUS RTU, MODBUS/TCP or JBUS protocols
- The integration of UPS in Network Management Systems through SNMP protocol
- Two slots for additional connectivity cards are available for specific protocol requirements.

Software Connectivity

Liebert® Nform™ will monitor the Liebert EXL S1 via SNMP protocol. Authenticated alarm management, trend analysis and event notification delivers a comprehensive monitoring solution. Available in a variety of versions to suit anything from small computer rooms to multiple location distributed IT networks, Liebert Nform enables:

- Condition based system state recording
- Alarm event exporting to disk
- SMTP email
- Execution of external program
- Shut down clients

Liebert SiteScan® is a centralized site monitoring system which ensures maximum visibility and availability of critical operations. Liebert SiteScan Web allows users to virtually monitor and control any piece of critical support equipment. Its features include real-time monitoring and control, data analysis, trend reporting, and event management.

VERTIV™ TRELLIS™ PLATFORM

Vertiv's *Trellis* platform is a real-time infrastructure optimization platform that enables the unified management of data centre IT and facilities infrastructure.

The *Trellis* platform software can manage capacity, track inventory, plan changes, visualize configurations, analyze and calculate energy usage, and optimize cooling and power equipment.

The *Trellis* platform monitors the data center, providing a thorough understanding of system dependencies to help IT and facilities organizations keep the data center running at peak performance. This unified and complete solution, delivers the power to see the real situation in your data center, make the right decision and take action with confidence.

Liebert® EXL S1 From 250 to 1200 kW

Global presence for a close partnership. Everywhere.

Global AC Power Sites

 **4** Laboratories and R&D

 **5** Manufacturing Sites

 **3** Witness Test Sites

 **9** Main Training Centers

 Global Network of Regional Sales and Service Representatives

AC Power Highlights

 **100K+**
Square meter of manufacturing space

 **Up to 12MW**
available for witness tests

 **92k**
hours of technical training each year

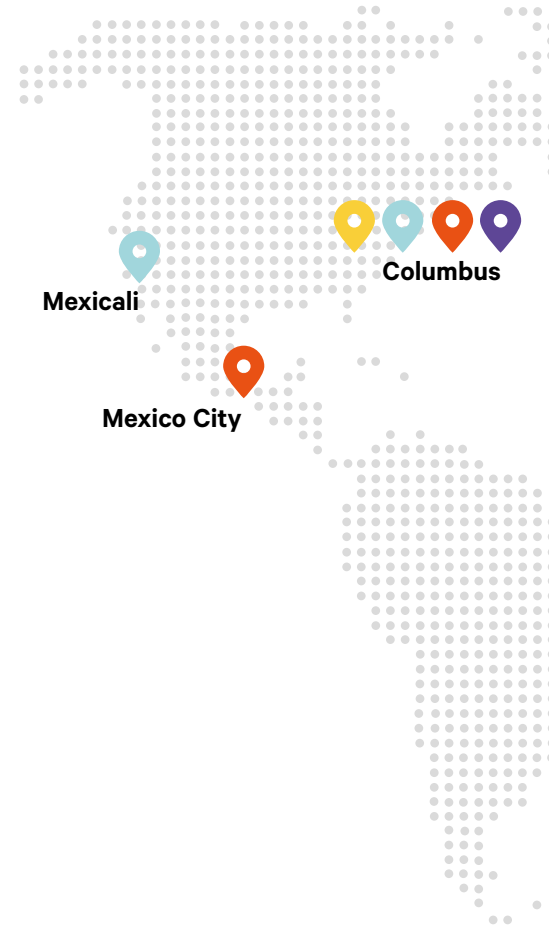

Main Witness Test and Customer Experience Center sites.

Vertiv™ state-of-the-art Customer Experience Centers enable our customers to experience first-hand a wide variety of data center technologies, supported by constant consultation from R&D and engineering specialists. Each center also offers virtual tests allowing customers to attend remote experiences.

Bologna, Italy - Customer Experience Center

- **800+** Customers every year
- From **50+** countries
- **10+** people dedicated
- **1700 m²** Witness Testing
- **650 m²** Showroom
- **650 m²** Academy
- **4** testing stations, each providing up to 1.2 MVA of capacity = total 2.5 MW
- **140+** witness test every year
- **400+** UPS systems tested each year
- **Up to 4000 A** simultaneous test at full load

Validation experiences

- **Demo** on new products to demonstrate UPS performance
- **Standard** validation test showing UPS performances
- **Customized** session to validate customer's specific needs.



Delaware, US - Power Test Center

- **4.000+** m², including **260+** m² customer observation suite
- **7** test bays, each containing multiple distinct test stations
- **800+** tour each year

Validation experiences

- **Steady-state** - 0% to 100% plus overload, unbalanced loading; non-linear loading
- **Dynamic** - 0% to 100% step loads plus overload, unbalanced loading; non-linear loading
- **Overload and faults** (>100%, 125%, 150%)
- **Customer special tests**



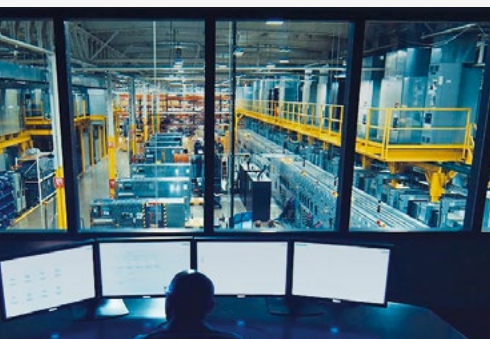
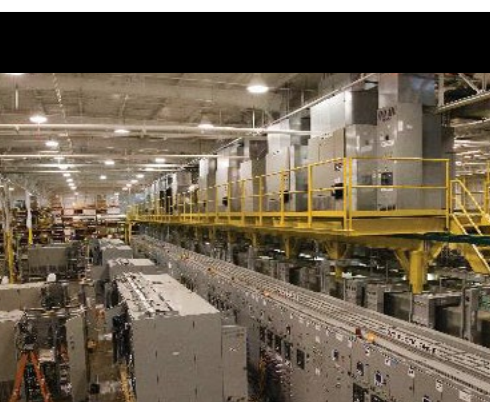

Shenzhen, China - Power Test Center

- **100+** Customers every year
- From **25+** countries
- **5+** people dedicated
- **180 m²** Witness Testing
- **60 m²** Showroom
- **4** testing stations, each providing up to 1.2 MVA of capacity = total 2.5 MW
- **100+** witness test every year
- **100+** UPS systems tested each year
- **Up to 1.8 A** simultaneous test at full load

- Validation experiences**
- **Demo** on new products to demonstrate UPS performance
 - **Standard** validation test showing UPS performances
 - **Customized** session to validate customer's specific needs.



Liebert® EXL S1 From 250 to 1200 kW

Technical Specifications	250/300/400	500/600	625/750/800	1000/1100/1200
UPS Rating (kVA)	250/300/400	500/600	625/750/800	1000/1100/1200
Output Active Power at 104°F (40°C) (kW)	250/300/400	500/600	625/750/800	1000/1100/1200
Input AC Parameters				
Input Voltage to Rectifier/ Bypass (VAC)	480, 3-phase, 3-wire			
Permissible Input Voltage Range	+10%, -15%			
Input Frequency (Hz)	60 ± 5Hz			
Input Power Factor	≥ 0.99			
Input Current Distortion (THDi) at Nominal Voltage at Full Load (%)	≤ 3.0			
Power Walk-in (seconds)	1 to 300 (selectable in 1 second increments)		1 to 300 (selectable in 1 second increments)	
Battery & DC Parameters				
Battery Type	Lithium ion, VRLA (Valve Regulated Lead Acid), VLA (Vented Lead Acid)			
Nominal Battery Bus (VDC) / Battery Float Voltage (VDC)	480 / 540			
DC Ripple at Float Voltage	< 1.0% (RMS value) < 3.4% Vpp			
Temperature Compensated Battery Charging	Standard with Vertiv™ Battery Cabinets			
Output Parameters				
Load Power Factor Supported (Without Derating)	0.7 Leading to 0.4 Lagging			
Output Voltage (VAC)	480, 3-phase, 3-wire			
Output Voltage Regulation (%) / Output Voltage Regulation (50% Unbalanced Load) (%)	< 1.0 (3-phase RMS average) / < 2.0 (3-phase RMS average)			
Output Frequency (Hz)	60 ± 0.1%			
Output THD at Nominal Voltage (Linear Load) (%)	≤ 1.5 (RMS value)			
Output THD at Nominal Voltage including a 100kVA Non Linear Load per IEC 6204-3 (%)	≤ 5.0 (RMS value)			
Transient Recovery 100% Load Step / 50% Load Step / Loss of/Return to AC Input Power	±4% / ±2% / ±2% (RMS average for one cycle)			
Voltage Displacement (Balance Loads) / Voltage Displacement (50% Balance Loads)	120 deg ±1 deg / 120 deg ±2 deg			
Overload at Nominal Voltage and 77°F (25°C)	110% continuously, 125% for 10 minutes, 150% for 60 seconds, 200% for 200 milliseconds			
Physical Characteristics				
Dimensions with Standard I/O Cabinet, W x D x H	51.3 in x 36.0 in x 79.1 in	63.0 in x 36.0 in x 79.1 in	78.8 in x 36.0 in x 79.1 in	104.5 in x 36.0 in x 79.1 in
Dimensions with BFD or Sharing Inductor I/O Cabinet, W x D X H	63.2 in x 36.0 in x 79.1 in	74.8 in x 36.0 in x 79.1 in	109.4 in x 36.0 in x 79.1 in	128.1 in x 36.0 in x 79.1 in
Weight with Standard I/O Cabinet, Unpackaged	1869 lbs	2750 lbs	3508 lbs	4667 lbs
Weight with BFD or Sharing Inductor I/O Cabinet, Unpackaged	2269 lbs (max)	3050 lbs (max)	5665 lbs (max)	6523 lbs (max)
Color	Black, RAL 7021			
Protection Class, UPS Enclosure	NEMA 1, IP 20 (with and without front door open)			
Environmental				
Operating Temperature	32°F to 104°F (0°C to 40°C)			
Relative Humidity	0% to 95%, non-condensing			
Operating Altitude	Up to 3300 ft (1000 m) without derating			
Communications				
Options	2 Liebert® Intellislots			
Card Compatibility	IS-UNITY-DP, IS-485EXI			
Protocols Available	MODBUS-IP, MODBUS-485, BACNET-IP, BACNET-MSTP, SNMP, HTTP, LIFE™ Services			
Standards				
Transportation / Safety	ISTA Procedure 3B / UL 1778 5th Edition; CSA 22.2 NO 107.3			
EMI / Surge	IEC 62040-2; FCC Part 15, Class A / ANSI C624.41, Category B3			
Seismic	IBC 2015, CBC 2016, ASCE, OSHPD			

Data Center Infrastructure for Large Applications

Static Transfer Switch



Liebert STS2

- Ensures redundant power for critical loads, switching between two independent power sources
- Patented Optimized Transfer protocol eliminates transformer saturation (inrush) and allows for 180° out of phase transfers between sources
- Market leading reliability with 3P and 4P architectures allowing full PF range which guarantees compatibility with all load types.

UPS



Liebert® Trinergy™ Cube 1600 kW

- Highest average operating efficiency in the industry: 99%, with dynamic online mode
- Distributed and centralized battery configurations
- Unprecedented levels of installation flexibility
- Hot modularity up to 1600 kW.



Liebert® EXL S1 1200 kW

- Three-level double conversion efficiency of up to 97% plus intelligent paralleling
- Dynamic online mode (VI) efficiency up to 99%
- Intelligent ECO mode (VFD) efficiency above 99%
- Enhanced energy density and compact footprint
- Parallel system configuration up to 8 units with both centralized and distributed parallel capabilities.



Liebert® EXM 10-250kVA/kW

- Flexible, modular UPS for Room and Row applications
- Scalable and supports N+1 redundancy
- Three-level double conversion
- efficiency up to 97% and 99% in Eco mode
- Satisfies diverse site requirements in small, optimized footprint.

Remote Diagnostics

Vertiv™ LIFE™ Services Remote Diagnostic and Preventive Monitoring

With Vertiv LIFE Services you will benefit from:

- Uptime assurance
- First time fix rate
- Proactive analysis
- Minimized total cost of ownership of your equipment
- Fast incident response
- Reporting.



1 AC Power

2 Infrastructure Management & Monitoring

3 Power Switching & Controls

4 Thermal Management

5 Racks & Integrated Cabinets

6 Surge Protection

7 DC Power



Vertiv.com | Vertiv Headquarters, 1050 Dearborn Drive, Columbus, OH, 43085, USA

© 2020 Vertiv Group Corp. All rights reserved. Vertiv™ and the Vertiv logo are trademarks or registered trademarks of Vertiv Group Corp. All other names and logos referred to are trade names, trademarks or registered trademarks of their respective owners. While every precaution has been taken to ensure accuracy and completeness here, Vertiv Group Corp. assumes no responsibility, and disclaims all liability, for damages resulting from use of this information or for any errors or omissions. Specifications, rebates and other promotional offers are subject to change at Vertiv's sole discretion upon notice.